

NOVA, NORA - korpus 180

MONTÁŽ KORPUSU POSTELE

montážny krok 1

Obalový materiál kartón a polyetylénovú fóliu po rozbalení výrobku vhodte do kontajneru s označením papier a plasty. Po rozbalení výrobku zmontujte výrobok nasledovným spôsobom :

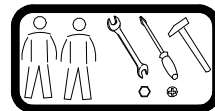
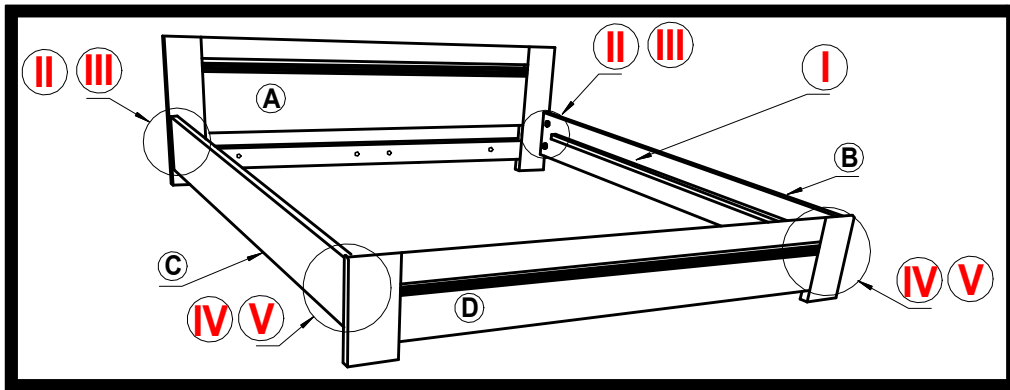

- | | | | | | | | |
|--------------------------|----------------------------|-----------------------------|---------------------------|-----------------------------|-----------------------|----------------------------|------------------------------|
| ①
Kolík 10x40 - 16 ks | ②
Sektor skrutka - 4 ks | ③
Sektor podložka - 8 ks | ④
Skrutka M6x70 - 4 ks | ⑤
sektor. kľúč..... 1 ks | ⑥
Matica M6 - 4 ks | ⑦
Okená podložka - 4 ks | ⑧
Filcová podložka - 8 ks |
|--------------------------|----------------------------|-----------------------------|---------------------------|-----------------------------|-----------------------|----------------------------|------------------------------|

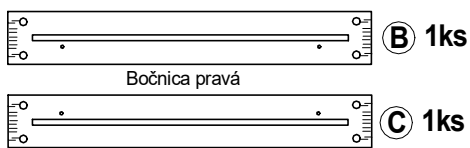

Znaky a ich vysvetlenie :

- ①, ②, ③..... MONTÁŽNE KOVANIE
- A, B, C..... DIELCE POSTELE
- I, II, III..... POSTUP MONTÁŽE
- ①, ②, ③..... POSTUP KROKOV

I

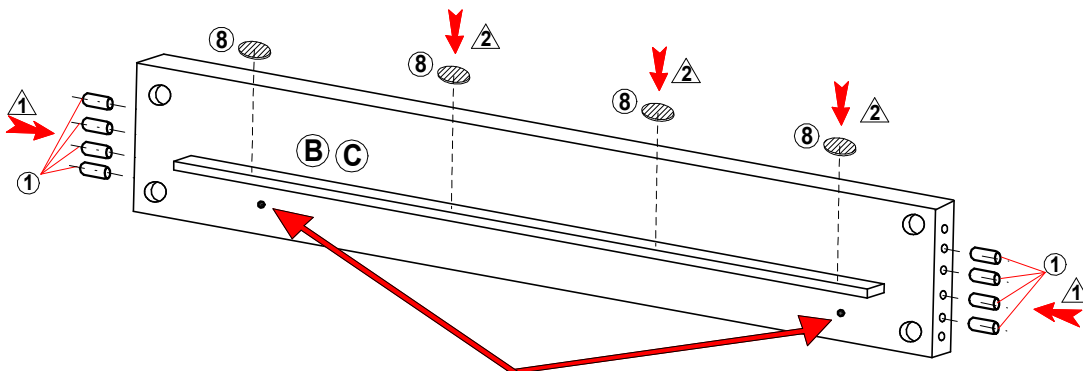

II, III - Montáž zadného čela A s bočnicami B a C

POZOR !!! Otočiť' bočnicu vrtaním dole !

II

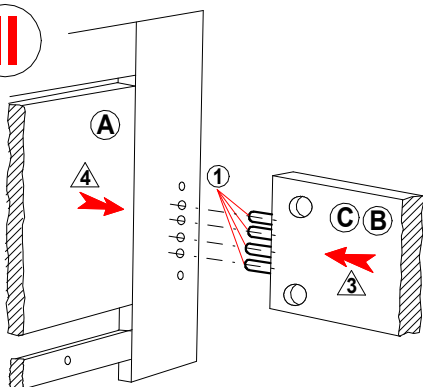

III

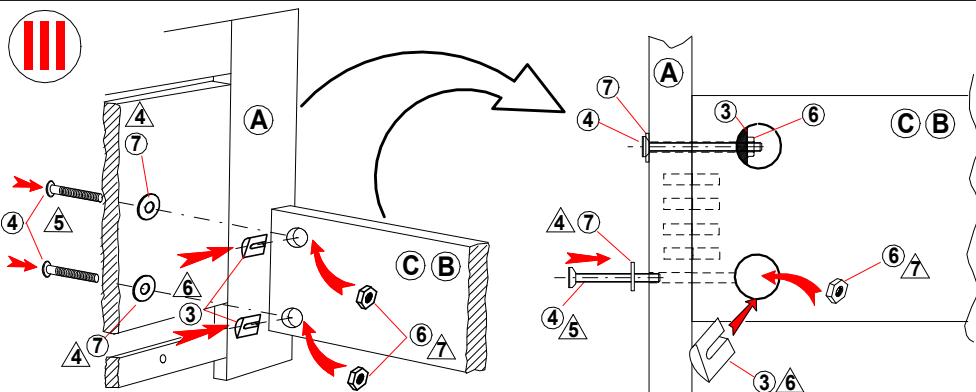

IV, V - Montáž predného čela D s bočnicami B a C

IV

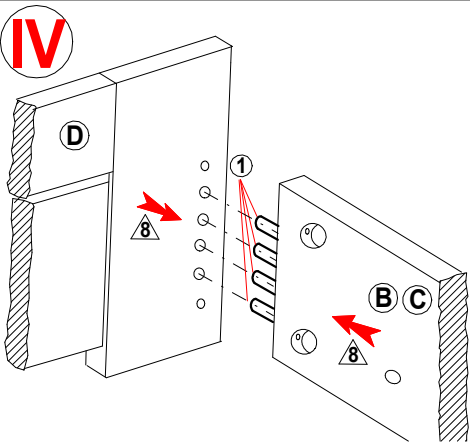

V

